

NAADLOZE LASBOCHTEN 2D 90°

Naadloze stalen lasbochten volgens DIN 2605 type 2S vervaardigd uit materiaal St.35.8 kl.1 volgens DIN 17175

of volgens EN 10253-2 type 2D uit materiaal P235GH TC1.

Met gladde einden volgens DIN 2559-1, vanaf 3mm wanddikte met afgeschuinde einden DIN 2559-21/22. Desgewenst met fabriekscontroleattest EN 10204/3.1



VAN DER WAGT BV - SASSENHEIM

Postbus 90 2170 AB Sassenheim
Industriekade 36 2172 HW Sassenheim
Tel. 0252 211448 Fax. 0252 215267

E-mail: info@vanderwagtbv.nl
Homepage: www.vanderwagtbv.nl

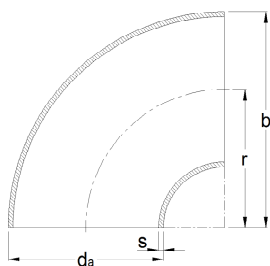

Groep	2
Bladnummer	1

Artikelnr.	nom.	uitw.		wanddikte			gewicht kg. 90°
		da	s	r	b	e	
	15	21.3	2.0	17,5	28	7	0.03
969002623	20	26.9	2.3	25	39	10	0.05
969003326	25	33.7	2.6	25	42	10	0.09
969004226	32	42.4	2.6	32	53	13	0.15
969004826	40	48.3	2.6	38	62	16	0.20
969005729	50	57	2.9	52.5	81	22	0.32
969006029	50	60.3	2.9	51	81	21	0.36
969007629	65	76.1	2.9	63	102	26	0.58
969008832	80	88.9	3.2	76	121	32	0.88
969010836	100	108	3.6	100	154	41	1.46
969011436	100	114.3	3.6	102	159	42	1.63
969013340	125	133	4.0	125	192	52	2.50
969013940	125	139.7	4.0	127	197	53	2.80
969015945	150	159	4.5	150	230	62	4.04
969016845	150	168.3	4.5	152	237	63	4.40
969021963	200	219.1	6.3	203	313	84	10.50

NAADLOZE LASBOCHTEN 3D 90°

Naadloze stalen lasbochten volgens DIN 2605 type 3S vervaardigd uit materiaal St.37.0 volgens DIN 1629

of volgens EN 10253-1 type 3D uit materiaal S235.

Met gladde einden volgens DIN 2559-1, vanaf 3mm wanddikte met afgeschuinde einden DIN 2559-21/22. Desgewenst met fabriekscontroleattest EN 10204/2.2.

Lasbochten materiaal St.35.8/I-S DIN 17175 (Wst.-Nr. 1.0305) of P235GH TC1 EN10216-2 op aanvraag.



VAN DER WAGT BV - SASSENHEIM

Postbus 90 2170 AB Sassenheim
Industriekade 36 2172 HW Sassenheim
Tel. 0252 211448 Fax. 0252 215267

E-mail: info@vanderwagtbv.nl
Homepage: www.vanderwagtbv.nl

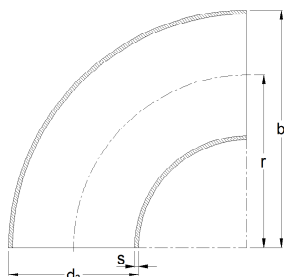

Groep	2
Bladnummer	2

Artikelnr.	nom.	uitw.		wanddikte			gewicht kg. 90°
		da	s	r	b	e	
919002120	15	21.3	2.0	28	38	12	0.04
919002623	20	26.9	2.3	29	43	12	0.07
919003326	25	33.7	2.6	38	56	16	0.12
919004226	32	42.4	2.6	47.5	69	20	0.19
919004826	40	48.3	2.6	57	82	24	0.27
919005729	50	57	2.9	72	100	30	0.44
919006029	50	60.3	2.9	76	106	32	0.49
919007629	65	76.1	2.9	95	133	39	0.79
919008832	80	88.9	3.2	114.5	159	47	1.22
919010836	100	108	3.6	142.5	196	59	2.08
919011436	100	114.3	3.6	152	210	63	2.37
919013340	125	133	4.0	181	247	75	3.64
919013940	125	139.7	4.0	190.5	260	79	4.04
919015945	150	159	4.5	216	294	89	5.80
919016845	150	168.3	4.5	229	313	95	6.50
919021963	200	219.1	6.3	305	414	126	14.90
	250	267	6.3		512	157	24.10
919027363	250	273	6.3	381	518	158	24.90
919032371	300	323.9	7.1	457	619	189	40.00
919035580	350	355.6	8.0	533	711	221	57.20
919040688	400	406.4	8.8	610	813	253	82.20

NAADLOZE LASBOCHTEN 3D 45° en 180°

Naadloze stalen lasbochten volgens DIN 2605 type 3S vervaardigd uit materiaal St.37.0 volgens DIN 1629

of volgens EN 10253-1 type 3D uit materiaal S235.

Met gladde einden volgens DIN 2559-1, vanaf 3mm wanddikte met afgeschuinde einden DIN 2559-21/22. Desgewenst met fabriekscontroleattest EN 10204/2.2.

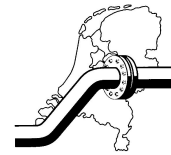

VAN DER WAGT BV - SASSENHEIM

Postbus 90 2170 AB Sassenheim
Industriekade 36 2172 HW Sassenheim
Tel. 0252 211448 Fax. 0252 215267

E-mail: info@vanderwagtbv.nl
Homepage: www.vanderwagtbv.nl

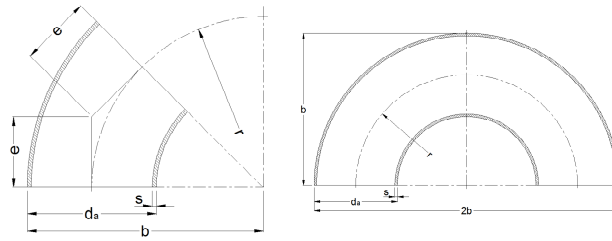

Groep	2
Bladnummer	3

Artikelnr.	nom.	uitw.		wanddikte			gewicht kg. 90°
		da	s	r	b	e	
	15	21.3	2.0	28	38	12	0.04
	20	26.9	2.3	29	43	12	0.07
	25	33.7	2.6	38	56	16	0.12
	32	42.4	2.6	47.5	69	20	0.19
	40	48.3	2.6	57	82	24	0.27
	50	57	2.9	72	100	30	0.44
914506029	50	60.3	2.9	76	106	32	0.49
914507629	65	76.1	2.9	95	133	39	0.79
914508832	80	88.9	3.2	114.5	159	47	1.22
	100	108	3.6	142.5	196	59	2.08
914511436	100	114.3	3.6	152	210	63	2.37
	125	133	4.0	181	247	75	3.64
914513940	125	139.7	4.0	190.5	260	79	4.04
	150	159	4.5	216	294	89	5.80
914516845	150	168.3	4.5	229	313	95	6.50
914521963	200	219.1	6.3	305	414	126	14.90
	250	267	6.3		512	157	24.10
914527363	250	273	6.3	381	518	158	24.90
914532371	300	323.9	7.1	457	619	189	40.00
	350	355.6	8.0	533	711	221	57.20
	400	406.4	8.8	610	813	253	82.20

NAADLOZE LASBOCHTEN 5D 90°

Naadloze stalen lasbochten volgens DIN 2605 type 5S vervaardigd uit materiaal St.35.8 kl.1 volgens DIN 17175

of volgens EN 10216-2 type 5D uit materiaal P235GH TC1.

Met gladde einden volgens DIN 2559-1, vanaf 3mm wanddikte met afgeschuinde einden DIN 2559-21/22. Desgewenst met fabriekscontroleattest EN 10204/3.1



VAN DER WAGT BV - SASSENHEIM

Postbus 90 2170 AB Sassenheim
Industriekade 36 2172 HW Sassenheim
Tel. 0252 211448 Fax. 0252 215267

E-mail: info@vanderwagtbv.nl
Homepage: www.vanderwagtbv.nl

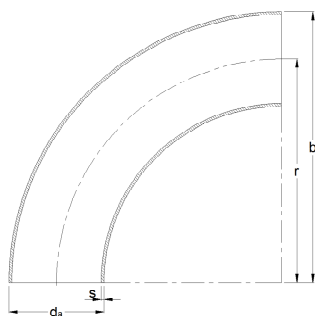

Groep	2
Bladnummer	4

Artikelnr.	nom.	uitw.		wanddikte			gewicht kg/stuk 90°
		da	s	r	b	e	
929002120	15	21.3	2.0	42.5	53	18	0.07
929002623	20	26.9	2.3	57.5	71	24	0.13
929003326	25	33.7	2.6	72.5	90	30	0.23
929004226	32	42.4	2.6	92.5	114	38	0.37
929004826	40	48.3	2.6	107.5	132	45	0.50
929005729	50	57	2.9	127.5	156	53	0.64
929006029	50	60.3	2.9	135	165	56	0.88
929007629	65	76.1	2.9	175	213	73	1.45
929008832	80	88.9	3.2	205	250	85	2.23
929010836	100	108	3.6	252.5	306	105	3.67
929011436	100	114.3	3.6	270	327	112	3.89
929013340	125	133	4.0	312.5	379	129	6.30
929013940	125	139.7	4.0	330	400	137	7.80
929015945	150	159	4.5	375	455	155	10.20
929016845	150	168.3	4.5	390	474	162	11.10
929021963	200	219.1	6.3	510	620	211	24.85
929026763	250	267	6.3		768	263	40.50
929027363	250	273	6.3	650	787	269	42.00
929032371	300	323.9	7.1	775	937	321	67.50
929035580	350	355.6	8.0	850	1028	352	95.33
929040688	400	406.4	8.8	970	1173	402	137.00

NAADLOZE LASBOCHTEN 5D 45° en 180°

Naadloze stalen lasbochten volgens DIN 2605 type 5S vervaardigd uit materiaal St.35.8 kl.1 volgens DIN 17175

of volgens EN 10253-2 type 5D uit materiaal P235GH TC1.

Met gladde einden volgens DIN 2559-1, vanaf 3mm wanddikte met afgeschuinde einden DIN 2559-21/22. Desgewenst met fabriekscontroleattest EN 10204/3.1

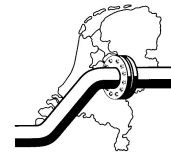

VAN DER WAGT BV - SASSENHEIM

Postbus 90 2170 AB Sassenheim
Industriekade 36 2172 HW Sassenheim
Tel. 0252 211448 Fax. 0252 215267

E-mail: info@vanderwagtbv.nl
Homepage: www.vanderwagtbv.nl

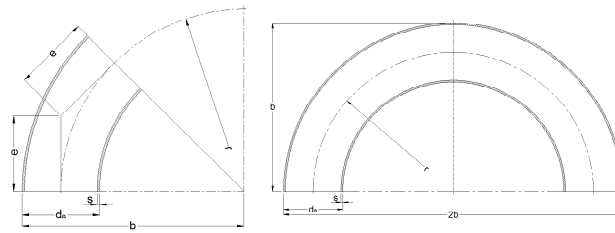

Groep	2
Bladnummer	5

nom.	uitw.		wanddikte			gewicht kg/stuk 90°
	da	s	r	b	e	
15	21.3	2.0	42.5	53	18	0.07
20	26.9	2.3	57.5	71	24	0.13
25	33.7	2.6	72.5	90	30	0.23
32	42.4	2.6	92.5	114	38	0.37
40	48.3	2.6	107.5	132	45	0.50
50	57	2.9	127.5	156	53	0.64
50	60.3	2.9	135	165	56	0.88
65	76.1	2.9	175	213	73	1.45
80	88.9	3.2	205	250	85	2.23
100	108	3.6	252.5	306	105	3.67
100	114.3	3.6	270	327	112	3.89
125	133	4.0	312.5	379	129	6.30
125	139.7	4.0	330	400	137	7.80
150	159	4.5	375	455	155	10.20
150	168.3	4.5	390	474	162	11.10
200	219.1	6.3	510	620	211	24.85
250	267	6.3		768	263	40.50
250	273	6.3	650	787	269	42.00
300	323.9	7.1	775	937	321	67.50
350	355.6	8.0	850	1028	352	95.33
400	406.4	8.8	970	1173	402	137.00